

User Manual

Tunable External Cavity Laser (G5) Integrated Spectral Bench (ISB5)



DAYY Photonics supports the technological needs of our customers by developing industry-leading light sources and custom photonic solutions.

Company Mission

To establish lasting relationships with our clients by providing reliable products, exceptional customer service, and ongoing support. Everyone at DAYY Photonics is part of our continuous improvement culture.

Company Vision

To illuminate the solutions that photonics can provide through continuous innovation of our own products and technology.

Quality Policy

At DAYY Photonics we use only the highest-quality components, manufactured consistently to our stringent specifications. After assembly, we test each system in-house before it is carefully packaged and shipped to customers. We ensure our customers receive well-built and thoroughly inspected products.

Contact Support

For any issues related to technical support or service, please contact:
techsupport@dayyphotonics.com

Table of Contents

1. Description.....	4
2. Safety.....	5
3. Operation.....	6
3.1 Parts List	6
3.2 Physical Driver Functionality	7
3.3 Hardware Requirements	11
3.4 Software Operation	11
4. Application Protocol Interface (API).....	22
4.1 Serial MODBUS-RTU (USB interface/RS232)	22
4.2 Tunable Laser ISB5 Register Map	22
5. Dimensions – ISB G5.....	23
6. Troubleshooting	24
7. DAYY Photonics Limited Product Warranty (“WRTY”)	25
8. Compliance	26
9. Acronyms	26
11. Contact Information	26

1. Description

DAYY's Tunable External Cavity Laser (ECL) can be tuned across a various ranges depending on the model chosen. The self-contained, tunable laser is based on the use of a semiconductor gain module and tunable filter. The optical output for this product is fiber-coupled via an FC/APC connector, and single mode or polarization maintaining fiber patch cables.

Software

A user-friendly GUI is included with this product which allows the user to select between single wavelength selection, single sweep, and continuous sweep modes. Operating parameters for each mode can also be set with in the GUI, and direct readout of the operating wavelength are also provided.

The laser can also be operated without the software GUI via modbus protocol with serial commands, which requires the instrument to be connected to the PC using the RS-232 or USB ports

Features

- Center wavelengths available: 785nm, 850nm, 930nm, 980nm, 1050nm, 1210nm, 1250nm, 1300nm, 1350nm, 1410nm, 1550nm, 1590nm, 1625nm, 1680nm
- Tuning range: 1nm-60nm depending on model
- FWHM: <0.1nm – 0.5nm depending on model
- Fiber-coupled output power: 10-30mW per wavelength
- Tuning speeds a few seconds, depending on range and increments
- Multiple communication interfaces: USB, RS-232
- User friendly GUI and custom API available for test automation

2. Safety

All statements regarding safety of operation and technical data in this user manual will only apply when the unit is operated correctly.

- ⚠ The driver must not be operated in environments susceptible to explosion hazards.
- ⚠ Do not obstruct the air ventilation slots.
- ⚠ If any parts of the driver, or electronics are broken or exposed, contact DAYY Photonics technical support and do not attempt to operate the unit.
- ⚠ The Fiber-coupled ISB5 is a Class 1M laser product. It is safe for all conditions of use except when passed through magnifying optics such as microscopes and telescopes. It produces a beam that is divergent. ***If light is re-focused use protective eye wear.***

3. Operation

3.1 Parts List

Inspect the shipping container for damage. If the shipping container seems to be damaged, keep it until you have inspected the contents and the unit mechanically and electrically.

Verify that you have received the following items within the package:

- 1 ECL Tunable Laser G5 Integrated Spectral Bench
- 1 Power supply. Input: AC 100-240V Output: 12V
- 1 Power Cord
- 1 USB 2.0 A to B Cable
- 1 User Manual
- 1 Final Inspection Test Report

3.2 Physical Driver Functionality

Side Panel - Power:

The power side panel consists of the 12V power jack and a two-position power switch to turn the unit ON/OFF as shown in Figure 1.



Figure 1: Power Side Panel

When the unit is plugged in and the power button is in the “I” (ON) position, the power LED of the front panel will light up.

The ISB5 can be powered up with the power supply provided by DAYY Photonics or with the user’s power supply if it fits the following specifications:

1. 12VDC (max. 14VDC) and minimum 3A current supply capability.
2. Power Barrel Connector Jack 2.00mm ID, 5.50mm OD, 9.5 mm Length.
3. Center Positive 

Side Panel – Communications and Control:

The right-side panel consists of a USB Type B connector and RS232 connector for communication. A 2-position slide type switch module and a TTL interface connector. The TTL connector is a 10 position, 2 row connector with 2.54mm pitch. It is recommended to mate with Samtec Inc. IPS1-105-01-L-D female socket; see Figure 2.

The left-most switch controls whether the driver will be operated in MANUAL MODE or PC MODE. The right-most switch enables the laser to be turned on and off.

If the driver is controlled through the PC-based software or DAYY Photonics API, connect either a USB or a Serial cable for communication. In MANUAL MODE the laser output can be turned ON/OFF with the switches on this side panel.

The left most switch puts the units in manual mode and when the right switch labeled “1” is in the “off” position the laser will be in idle mode. When running the laser in manual mode the laser will run at the default current setting. Default current settings for MANUAL MODE can be changed through the software. This will be explained in the Software Operation section (Section 3.4).

Unit scan status and laser wavelength synchronization can be interfaced through the TTL connector. TTL connector interface uses 5V for high and 0V for low. TTL pin out and timing will be explained in detail in the TTL Interface section of this user manual.

When running the DAYY software or through the custom API, toggle the left switch to PC MODE in order to control laser from the software. The laser control will be disabled in the software if operating in MANUAL MODE. Software will still display current levels when running in MANUAL MODE but users will not be able to adjust the operating current.

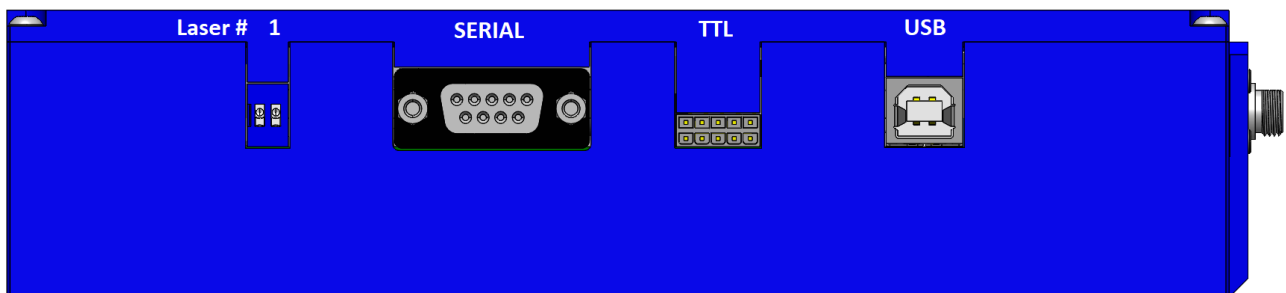

Figure 2: Communications and Control Panel

Front Panel - Light Output:

The front panel includes three LEDs, vent holes and light output connector, allowing users to connect their own fiber optic cable to the ISB5; see Figure 3. The ISB G5 comes with FC/APC as standard, but FC/PC and SMA connectors are available upon customer request.

When the unit is plugged in for power and the power button (side panel) is in the “I” position the red “POWER” LED will light up.

The yellow “READY” LED will start blinking until the unit is ready for operation. When the yellow “READY” LED stops blinking and stays on, the laser is enabled and users can turn it on. When laser is turned on and light is being emitted, the green “ON” LED will light up.

In the event of a fast and large temperature change in the environment, the unit may stop emitting light until the laser is ready again, in such case, the yellow “READY” LED will start blinking.

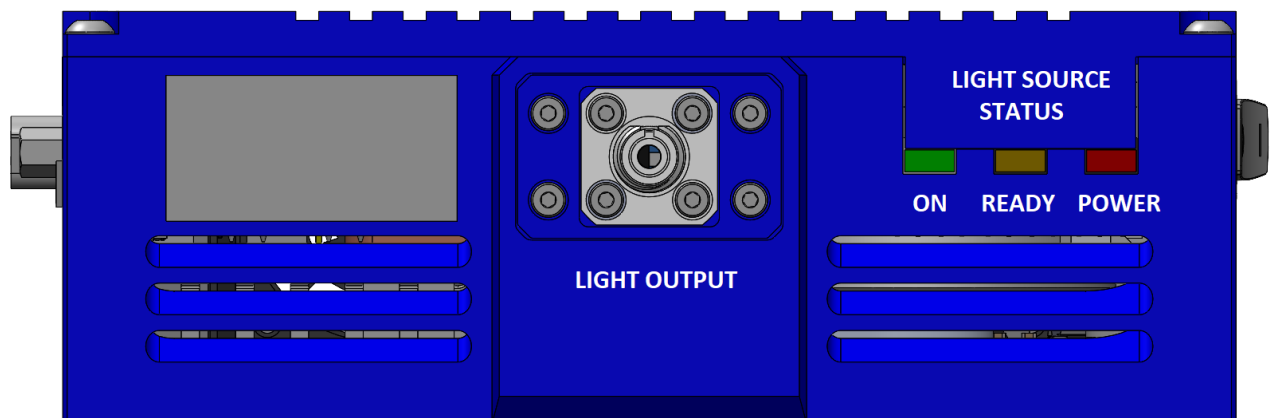

Figure 3: Front Panel – Light Output

Back Panel - Thermal Management:

Free air circulation around the rear of the unit should be maintained for good thermal performance. If the ISB5 is operated in environments over 40°C, the ISB5 should be mounted to an external heatsink. Free air circulation around the ISB5 is required when it is used without a heatsink. A minimum of 0.5” clearance is recommended for free air circulation around the top and sides of the ISB5 Unit.

Air circulation is located on the back panel of the ISB5, while additional ventilation holes are located on the front panel. Ensure vents are not obstructed to allow for maximum air flow. The back panel includes two fans as shown in Figure 4. Upon powering up the unit, each fan is regulated automatically to its maximum speed.

If the fan is not working and the heat sink temperature goes over 60°C, turn the unit off and contact DAYY Photonics technical support.

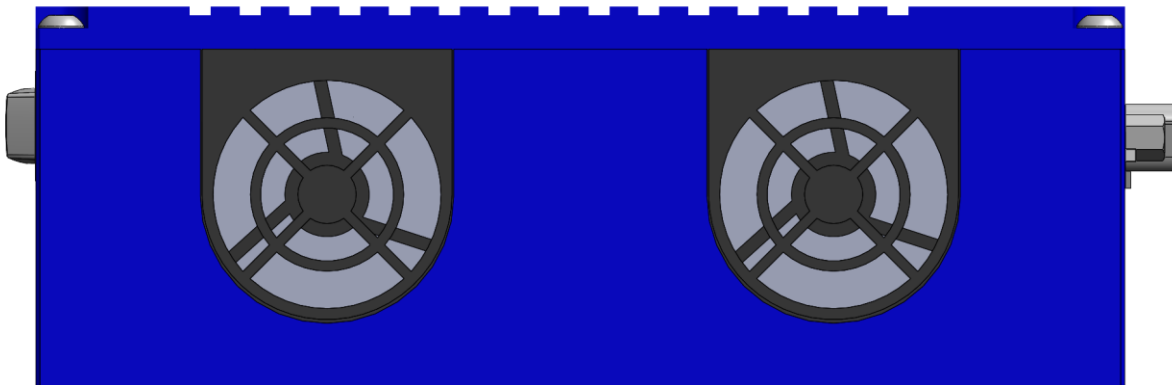

Figure 4: Back Panel – Thermal Management

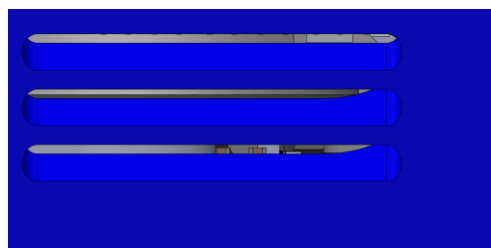

Figure 5: Front Panel – Thermal Vents

3.3 Hardware Requirements

CPU: 1 GHz or higher

RAM: 256 MB

Hard disc with at least 100 MB free storage space

USB 2.0, 3.0.

The driver is compatible with the following operating systems:

- Windows[®] 7 (32-bit, 64-bit)
- Windows[®] 8 (32-bit, 64-bit)
- Windows[®] 10 (32-bit, 64-bit)
- Windows[®] 11 (32-bit, 64-bit)

3.4 Software Operation

When starting up, the software will automatically scan your computer's ports and find the ECL G5 ISB. Please wait until a connection is established and the status bar in the bottom-left corner shows your connection type (USB/RS-232). Figure 6 shows the main console of the software.

Tunable Laser ISB5

4-5-2026 12:43 PM

ECL G5 Control

970.00 nm to 990.00 nm

Laser (mA)

700
650
600.0
550
500
450
400
350
300
290
200
150
100
50
0

Laser Power On

Laser Current
Set Max
Set Min

Control Mode
PC Mode

Set Current 600.0 mA
Actual Current 598.8 mA

Single Wavelength Mode

Wavelength 980.00 nm Save Set

Scan Mode

Wavelength	Save	Stored
Wavelength Start 970.00 nm	Save	970.00 nm
Wavelength End 990.00 nm	Save	990.00 nm
Wavelength step 0.10 nm	Save	0.10 nm

Scan Points 201

Single Scan START STOP

Continuous Scan START STOP

Laser Idle

System Performance

Scan Increment Delay 0.1 s Save

Laser Tuning RAW 5055 RF 90.550 MHz

System Temperatures

TEC Set Temp 10.0 °C TEC Capacity 53.2 %

TEC Mode Cooling TEC Temp 10.0 °C

Unit Ready -- Connection Type: USB

DAYY PHOTONICS

Current Laser Wavelength

980.00 nm

```

2026-04-05 12:43:02 PM | Starting up...
2026-04-05 12:43:02 PM | Auto Scanning COM Ports...
2026-04-05 12:43:03 PM | ECL ID verified successfully
2026-04-05 12:43:03 PM | ECL found on COM Port 5
2026-04-05 12:43:03 PM | Loading Configuration...
2026-04-05 12:43:03 PM | Boot done.
2026-04-05 12:43:03 PM | PC Mode Selected
2026-04-05 12:43:03 PM | Model number found.
2026-04-05 12:43:03 PM | Connection to ECL established.
    
```

Communications Logging Set Defaults About

Figure 5: Main Console of the ECL G5 ISB Driver

Laser Controls:

To turn on the laser you first turn the “Laser Power” on and then you can adjust the current from min to max values; see Figure 6.

Based on the ISB5 model, the maximum current will be limited and the sliders’ maximum values will be adjusted accordingly when the laser is connected. The wavelength tuning range will be displayed on the top left corner.



Figure 6: Laser Controls Section

The laser can be operated in 3 modes of operation, Single wavelength, Single Scan and Continuous Scan. Single wavelength you set the desired wavelength and hit “Save”, once the “Set” button is pressed the laser will stay on that wavelength which can be

seen on the main screen. For Single Scan and Continuous Scan, you set the desired Wavelength Start, end and step size. You must press the “Save” button for the setting to be stored. Then you can click the “START” button and the laser will stop at the End wavelength when the scan is complete. For Continuous Scan the laser will repeat the process until the “STOP” button is pressed.

The status window on Figure 7 shows the current laser wavelength and the mode you are in.

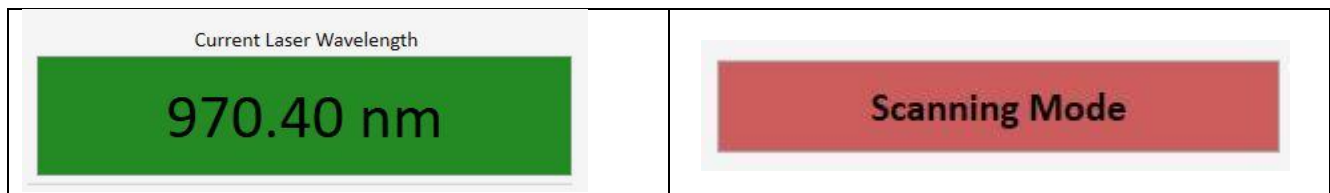

Figure 7: Current Wavelength

System Performance

The system performance section is used to identify the laser status and set the increment scan delay shown in Figure 8. The scan increment delay is used when doing single scan or continuous scan and will indicate the amount of time the laser will stay idle when the next wavelength is tuned too. Adjust the box in seconds and hit “Save” to store the value. When the unit starts, this field is automatically set to 0s.

The Laser Tuning box shows the current RF frequency and corresponding 16 bit RAW number used to tune the laser.



Figure 8. System Performance

System Temperatures

The real-time temperatures are shown per Figure 9. The thermoelectric cooler (TEC) for the semiconductor amplifier is shown the “TEC Temp” box. The “Laser TEC Mode” shows if the TEC is cooling or heating and the “Laser TEC Capacity” shows how hard the TEC is running.

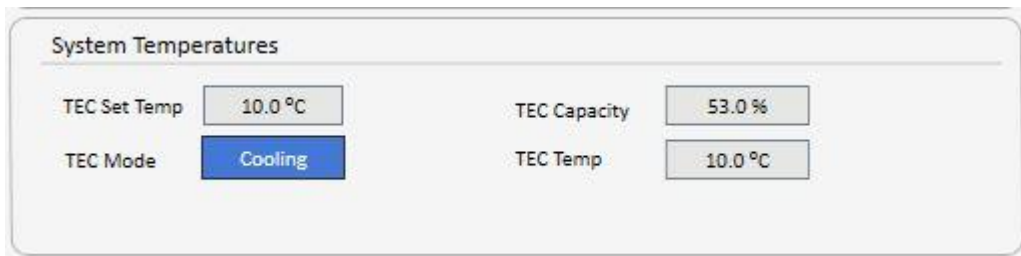

Figure 9: TEC Controls Section

TTL Interface

The pinout for the TTL interface is shown in Figure 10. It is recommended to use Samtec Inc. IPS1-105-01-L-D female socket to interface. The TTL interfaces uses 0V-3.3V for low and high respectively. Pin 2 “Laser Scan” will be high when the laser is in scanning mode and low when laser is single wavelength mode. Pin 3 “Laser Increment” will be high when the Laser is ready and goes low when the laser is tuning to new wavelength. Refer to timing diagram in Figure 11.

Note that Laser Power goes on automatically when in manual mode based on power setting in Defaults. Users can synchronize the wavelength the unit is outputting based on the scan settings, pin 2 and pin 3. Lastly pin 9 or 10 should be connected to ground.

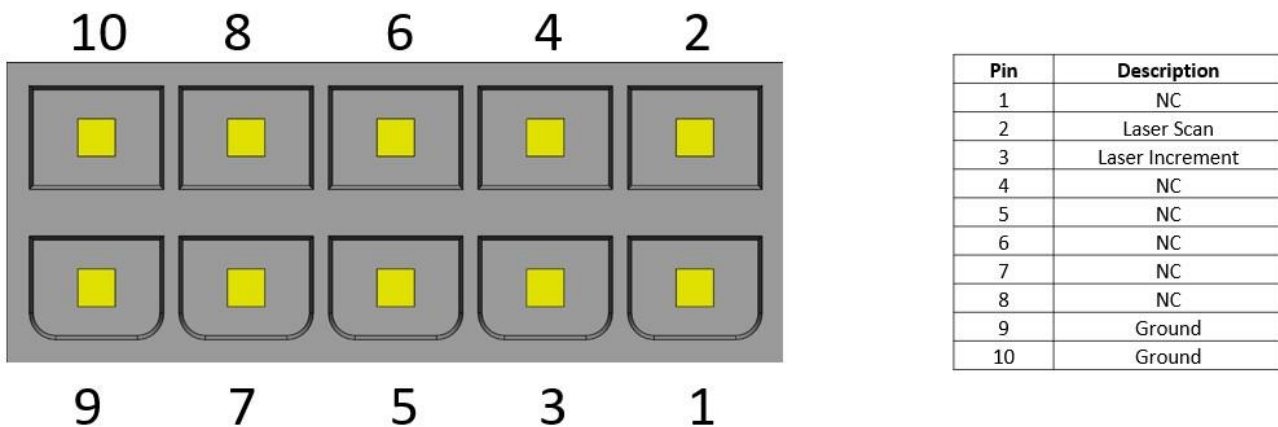

Figure 10: TTL Pin put

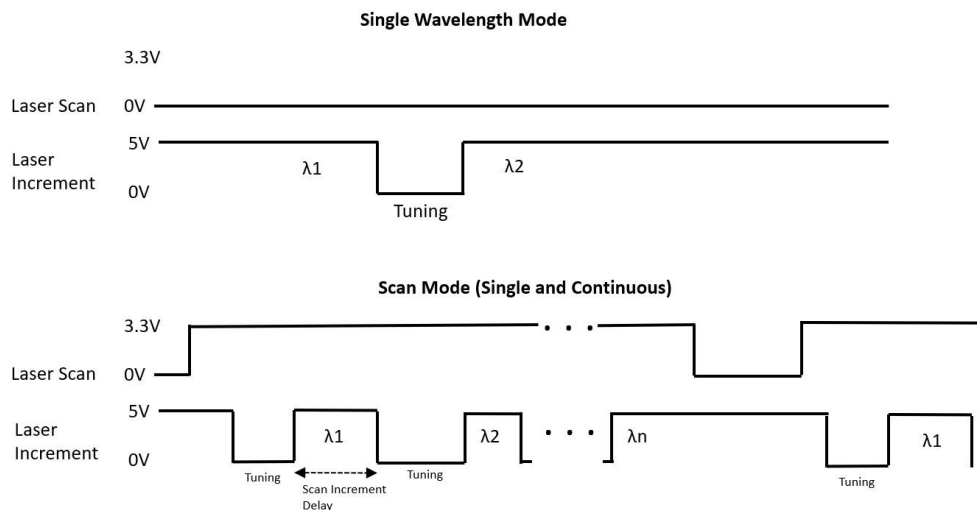

Figure 11: TTL Timing

Communications:

The screen shown in Figure 12 will appear when clicking on the “Communications” button from the main console. When software loads up, the Auto-Scan function will run to find the virtual com port settings for a USB and RS232. Users can manually enter the communication settings by clicking on “Autoscanning...” to stop the Auto-scan, then clicking “Manual Connect” to connect via their preferred communications settings. To Disconnect from a Manual Connection, click the “Disconnect” button.

USB/RS-232 Serial Configuration:

1. COM Port can be found on device manager
2. COM Speed should always be set to a 115200 Baud Rate
3. MODBUS ID is the unique identifier for the ISB5. It will be 1 by factory default. Multiple ISB2 Modules can be set up and used with different Modbus ID’s. To change Modbus ID, enter the new ID into the “Modbus ID” field before attempting to connect.

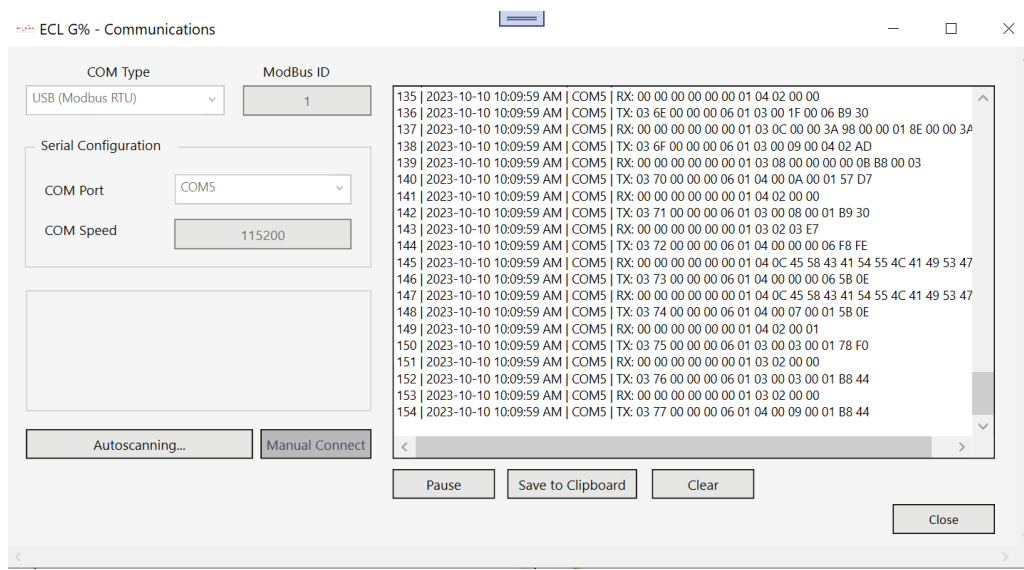

Figure 12: Communications Window

The Communications Window shows the continuous raw data transfers from the software to your ISB5 unit, and is used to monitor communications. The data transfer is represented as TX (data send) and RX (data receive) messages, accompanied by their time-stamps, see Figure 12. The Communications log can be paused by clicking “Pause,”

exported to a file by clicking “Save to Clipboard,” or the window can be emptied by clicking “Clear.”

In an event of a communication error, send the communication log to DAYY Photonics technical support at techsupport@dayyphotonics.com

Logging:

The ISB5 supports continuous logging of data such as the currents, temperatures, fan flow, etc. by clicking on the “Logging” tab from the main console. The window shown in Figure 13 will open. Enter the logging file name and directory for where the data is to be stored by clicking on the “...” button. After the filename and path have been selected, to start logging, click the check box before “Log to File” to enable the logging.

Note: Log Files must use the .csv (Comma Separated Value) file extension.

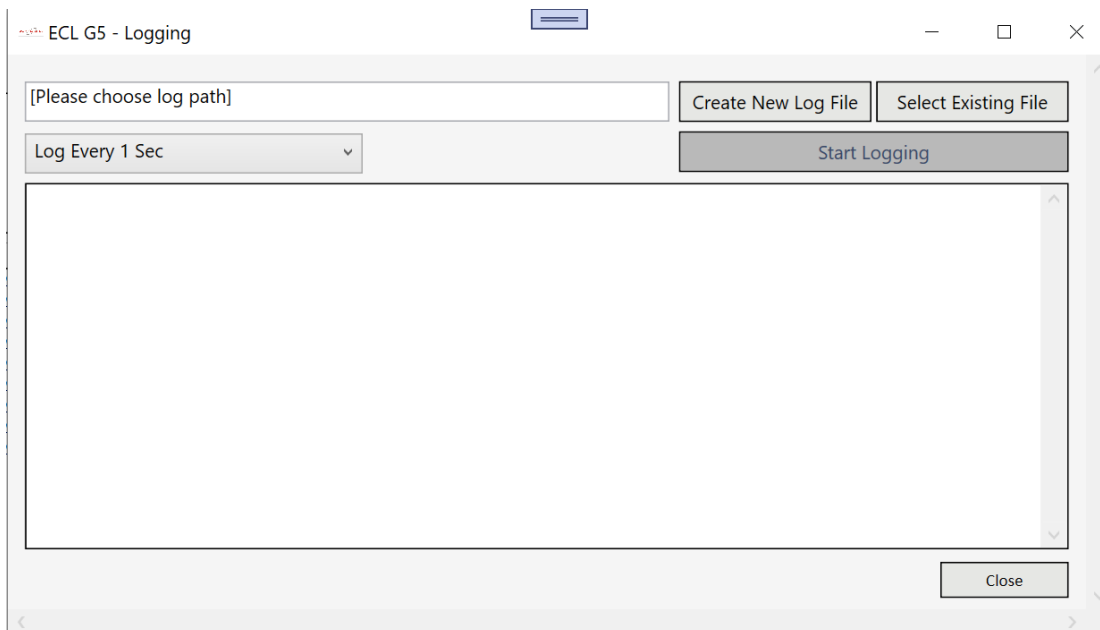
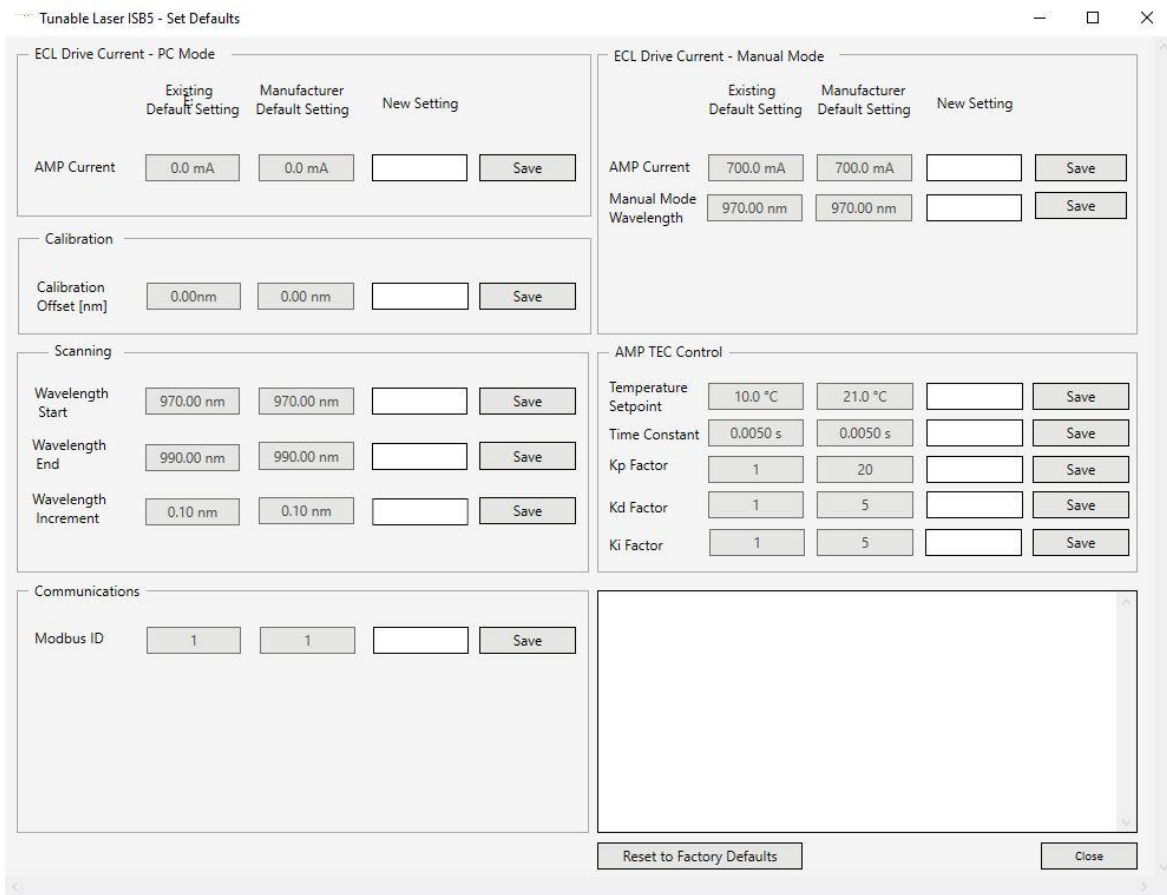

Figure 13: Data Logging Window

Set Defaults:

Clicking the “Set Defaults” tab from the main window will bring up the window displayed in Figure 14. For each of the parameters, the software displays the Existing Setting (First box from the left) and the Manufacturer Default Setting (Second box).

In order to change the value of any parameter, users must type the new value into the “New Setting” text field, then click the “Save” button next to this new value. Clicking this button will store the new value recorded in the “New Setting” field as its new default start-up setting. The new value will be stored in the Laser, and not on the user’s computer, so if the unit is powered off and taken to a different work station, the new settings will be kept as the default values when the unit is powered on again. The New Settings will remain stored in the driver until a different New Setting is saved, or “Reset to Factory Defaults” is clicked, which will reset all of these settings to their Factory Default Values.



Mode	Parameter	Existing Default Setting	Manufacturer Default Setting	New Setting	Action
ECL Drive Current - PC Mode	AMP Current	0.0 mA	0.0 mA		Save
	Calibration Offset [nm]	0.00nm	0.00 nm		Save
	Wavelength Start	970.00 nm	970.00 nm		Save
	Wavelength End	990.00 nm	990.00 nm		Save
ECL Drive Current - Manual Mode	AMP Current	700.0 mA	700.0 mA		Save
	Manual Mode Wavelength	970.00 nm	970.00 nm		Save
	Temperature Setpoint	10.0 °C	21.0 °C		Save
	Time Constant	0.0050 s	0.0050 s		Save
	Kp Factor	1	20		Save
	Kd Factor	1	5		Save
	Ki Factor	1	5		Save
Communications	Modbus ID	1	1		Save

Figure 14: Set Defaults Window

The section “AMP Current – PC Mode” allows user to set the initial current levels for laser when the unit is turned on and is in PC MODE.

The section “AMP Current – MANUAL MODE” consists of the operating current when the laser will be operated in MANUAL MODE.

Scanning defaults section allows you change the default scan values star, stop and increment. These values will be stored for next time the user power cycles the unit.

AMP TEC control allows user to change the thermal electric cooler settings, such as temperature, time constant and PID values.

Manual Mode Wavelength lets you set the wavelength unit will boot too when in manual mode

Users can change the Modbus ID of the unit, by Default “1” should be used unless a number of Lasers are connected to the same communications line.

Changes and notifications are displayed in the text box in the lower-right quadrant of the Set Defaults window. Unit needs to be power cycled for changes to come into effect from Set Default.

About:

Refer to the About section by clicking on the “About” button in the main console. The About window is shown in Figure 15. The software name and version are shown underneath DAYY Photonics logo. Based on the ISB5 model, the Capabilities column shows the functionality enabled on the driver.

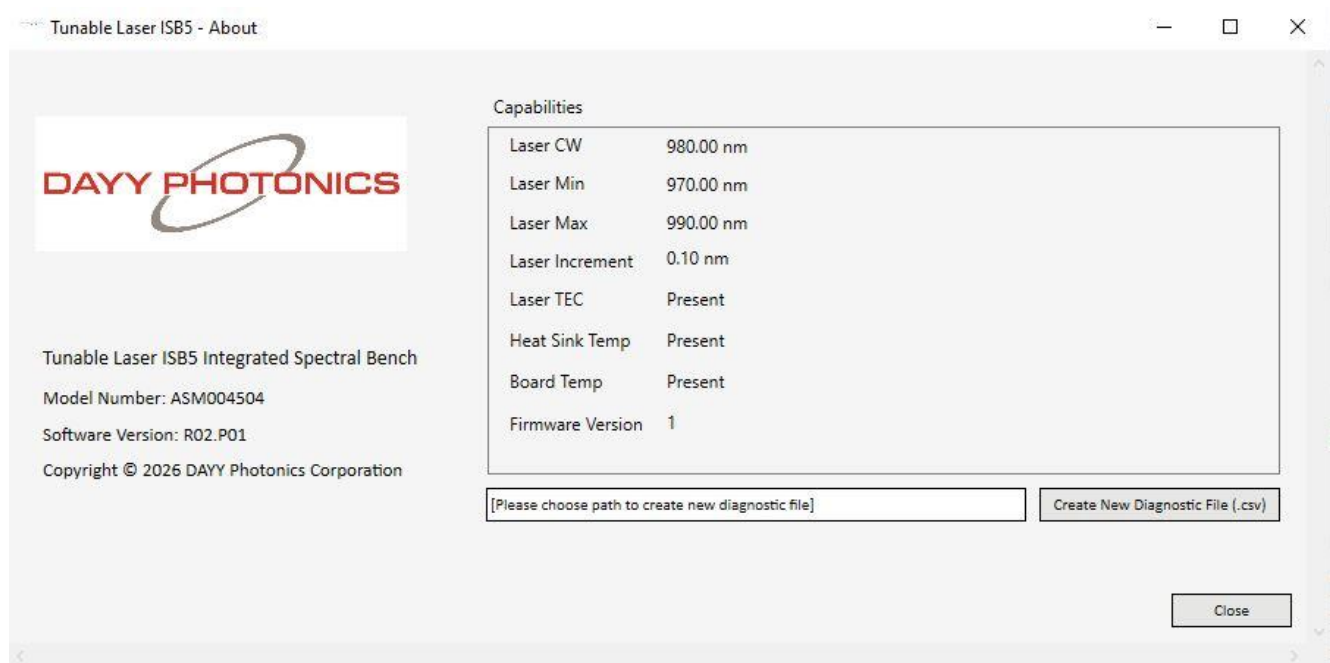

Figure 15: About Window

4. Application Protocol Interface (API)

DAYY driver utilizes the MODBUS Protocol for communications. Users can find numerous detailed specifications for the protocol on the internet. This manual will only provide a high-level overview. MODBUS is a master/slave protocol and is used widely in industrial applications. The driver is designed to use this protocol over all of its communication interfaces, and the MODBUS specification has outlined how a user can adapt the overall packet structure to suit each interface requirement. The primary section of a MODBUS packet is known as the Protocol Data Unit (PDU) and it is independent of the underlying communication interface. The PDU includes additional byte fields for the MODBUS transaction per the Application Data Unit (ADU).

4.1 Serial MODBUS-RTU (USB interface/RS232)

MODBUS over Serial Line is a master/slave protocol and is employed by the USB port. The ADU packet structure for each serial interface is shown below.

Serial Header	MODBUS PDU		Serial Footer	
Slave Address	Function Code	Data	CRC16	
1 byte	1 byte	0 up to 252 byte(s)	2 bytes	
			Low	High

As per the MODBUS Standard, this structure is used regardless of whether a packet is a request or a response. Each MODBUS-RTU packet consists of at least 4–256 bytes. The slave address byte is used to uniquely identify different units on the serial line and must be a number from 1 to 247. The function code byte indicates the request to perform. The Data bytes are dependent on the transaction data per the MODBUS protocol. The CRC16 bytes are transmitted with the low byte first and are calculated using the common CRC16 algorithm with the values of the slave address, function code, and the data bytes.

4.2 Tunable Laser ISB5 Register Map

If users want to develop their own API, ECL ISB5 Register Map is available upon request. Please contact technical support: techsupport@dayyphotonics.com

5. Dimensions – ISB G5

Overall dimensions for the connector, venting locations, and mounting holes.

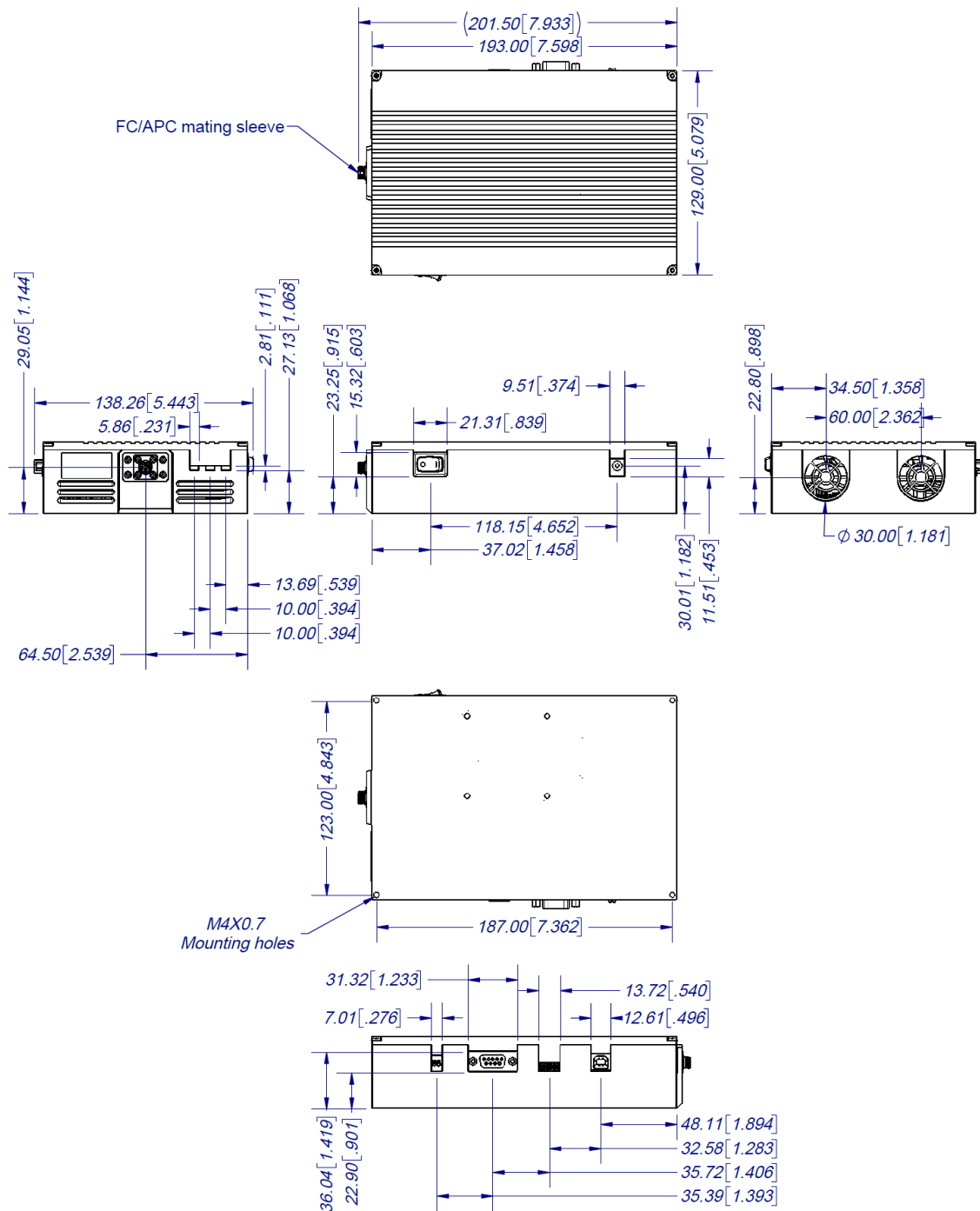

6. Troubleshooting

If an error occurs on your unit, operate the unit send diagnostic file to DAYY Photonics tech support.

To send the diagnostic file, follow these steps:

1. While your unit is connected and running, click on the “About” button on the main screen to open the About window.
2. Click “Select Diagnostic File” button and save with your desired filename and path (.csv extension)

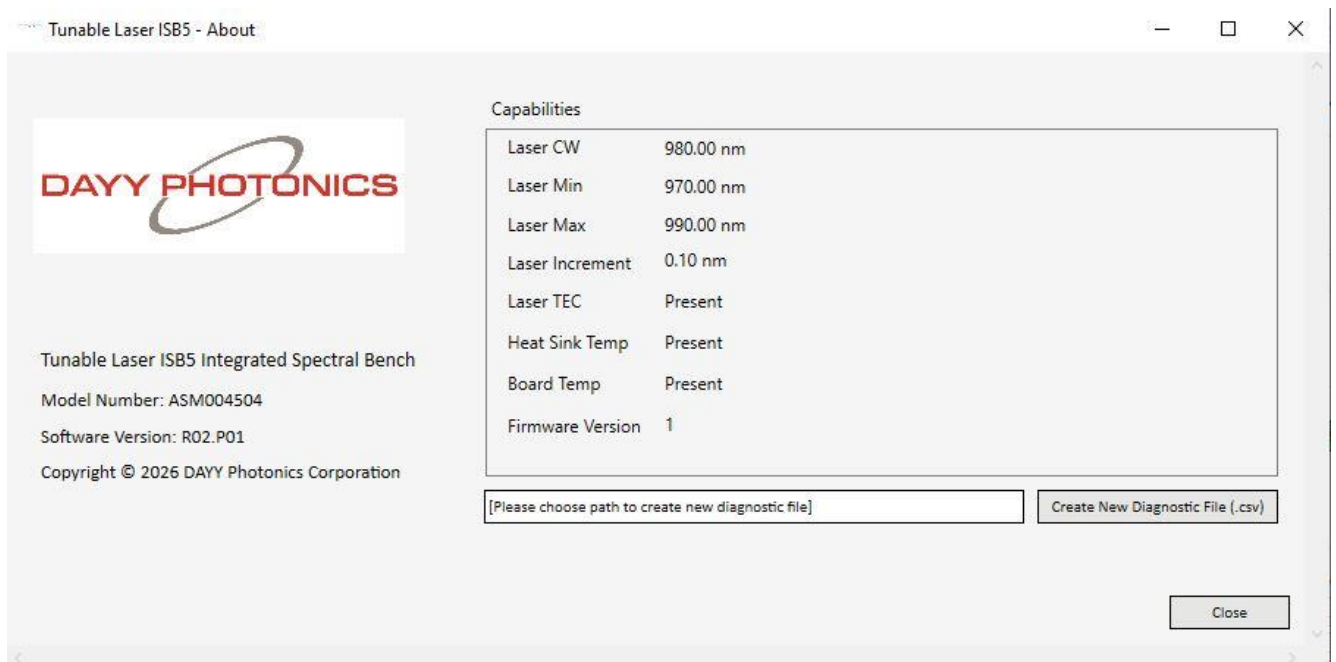

Figure 16: About Window

3. Attach this file along with a brief explanation in an e-mail and send to techsupport@dayyphotonics.com

7. DAYY Photonics Limited Product Warranty (“WRTY”)

DAYY Photonics Corporation (“DAYY”) products and components are warranted against defects in materials and workmanship for a period of one year (unless otherwise stated) beginning on the product shipment date. This warranty is provided only to the original end user, and is not transferrable. The warranty ceases upon transfer of the product to a new owner. Except as otherwise proscribed by applicable law, in the event of a breach of this warranty, the sole and exclusive remedy, and DAYY’s sole and exclusive liability, shall be for DAYY to use its commercially reasonable efforts to repair or replace the product that caused the breach of this warranty. If DAYY cannot, or determines that it is not practical to, repair or replace the returned product, then the sole and exclusive remedy and the limit of DAYY’s obligation under this warranty shall be to refund the amount received by DAYY for such product.

Warranty Returns

All products must be returned to DAYY in accordance with DAYY’s then-current Return Material Authorization (RMA) procedure. Products obtained from DAYY that do not comply with the warranty and which are returned to DAYY during the applicable warranty period will be repaired or replaced at DAYY’s option, provided the reseller or end user bears the cost of freight, insurance, duties and import and export fees to the point of repair or return. If the returned product is covered by a DAYY warranty, DAYY will bear the cost of freight, insurance, duties and import and export fees for return of goods to reseller (if any) or end user. If the product is purchased from a DAYY reseller, the reseller will handle and be responsible for the warranty return process for its end users. If the product was purchased directly from DAYY, the end user will be responsible for the warranty return process. For the first 30 days of the warranty period, DAYY will provide advance replacement same day ship via standard overnight shipping (must meet shipment cut-off time) for the covered product after confirming coverage and the warranty failure. The product arrival date is subject to local transport conditions. Additional service coverage such as Advanced Replacement service, or an extended warranty are available for purchase under a separate support and service agreement.

Warranty Exclusions and Disclaimer

The warranties described in this document do not extend to any product that is repaired, modified or altered by anyone other than DAYY or an DAYY authorized company, is not maintained to DAYY’s maintenance recommendations, is operated in a manner other than that specified by DAYY, has its serial number removed or altered. The warranty does not cover abuse of the product including but not limited to neglect, damage or abuse, such as water damage, back-reflection, broken fiber, incorrect input voltage, improper wiring, shock or severe impact, damage during shipment, exposure to rain, excessive humidity, corrosive environments or other contaminants are not covered by the terms and conditions of our warranty. The warranty does not cover cosmetic defects associated with normal wear that do not interfere with product functionality.

8. Compliance



9. Acronyms

ECL – External Cavity Laser
ISB - Integrated Spectral Bench
PCB – Printed Circuit Board
TEC – Thermal Electric Cooler
ESD – Electrostatic Discharge
API – Application Protocol Interface
PDU - Protocol Data Unit
ADU - Application Data Unit
MBAP - MODBUS Application Protocol
UI - Unit Identifier

11. Contact Information

DAYY Photonics Corporation
4030 8 St SE
Calgary, AB
Canada, T2G 3A7

+1 (587) 392-6192
sales@dayyphotonics.com
www.dayyphotonics.com